

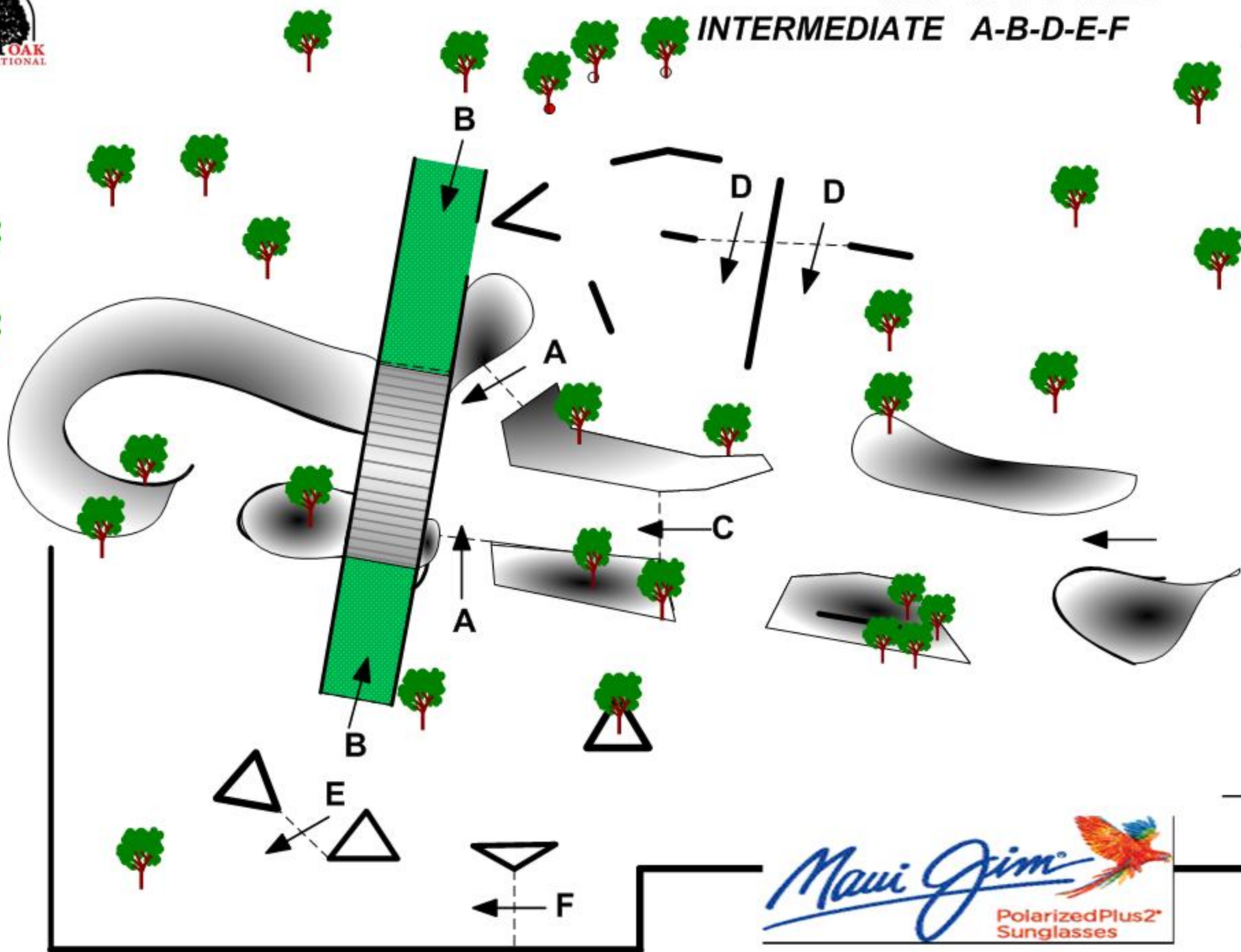

FEI A-B-C-D-E-F

INTERMEDIATE A-B-D-E-F

2



3

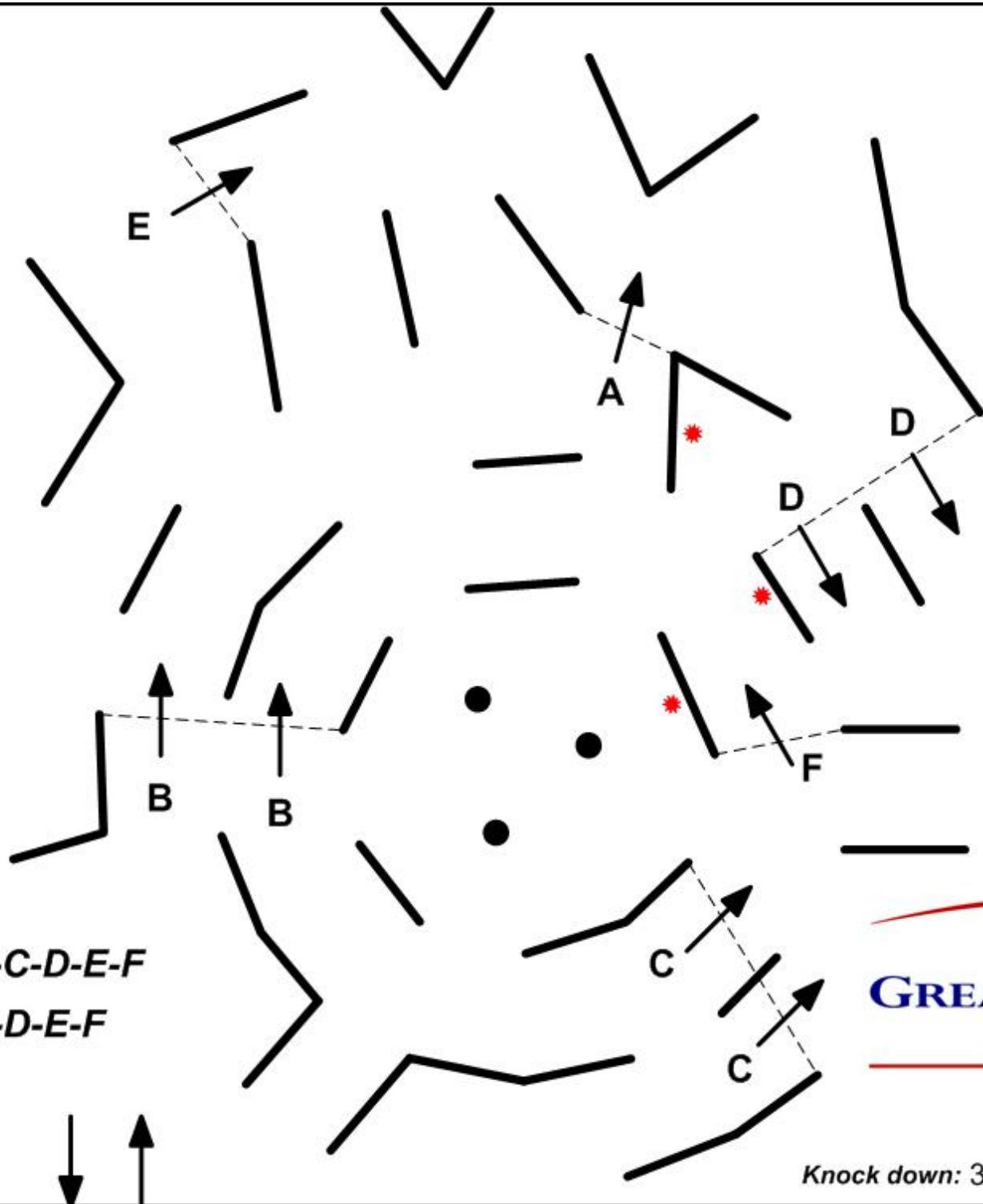

FEI A-B-C-D-E-F

INTERMEDIATE B-C-D-E-F



Knock down: 3

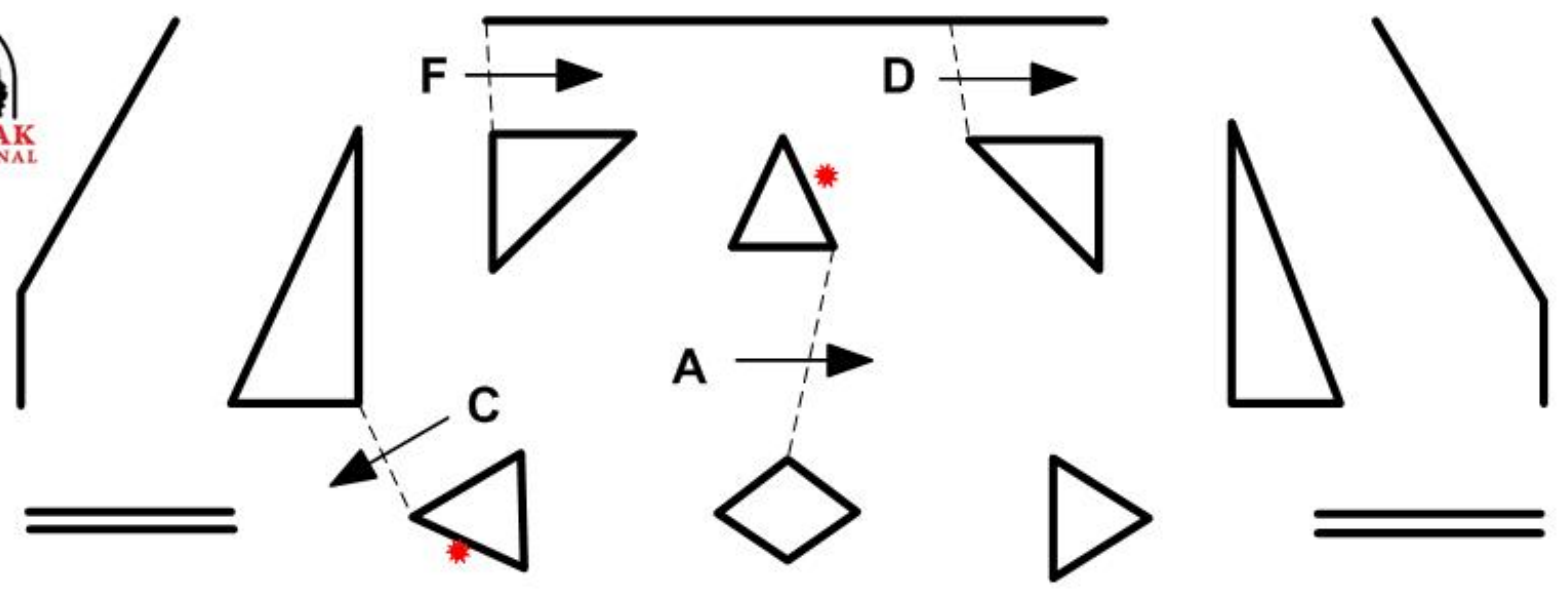

4



Knock down: 2

FEI A-B-C-D-E-F

INTERMEDIATE A-B-C-D-E

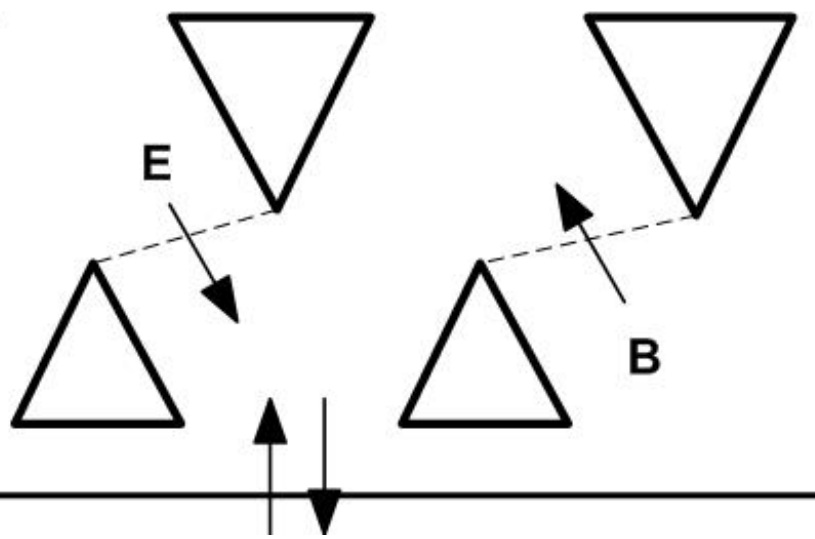

ARIAT.



SHEPHERD  
KAPLAN  
KROCHUK

FEI A-B-C-D-E-F  
INTERMEDIATE A-B-C-D-F

5

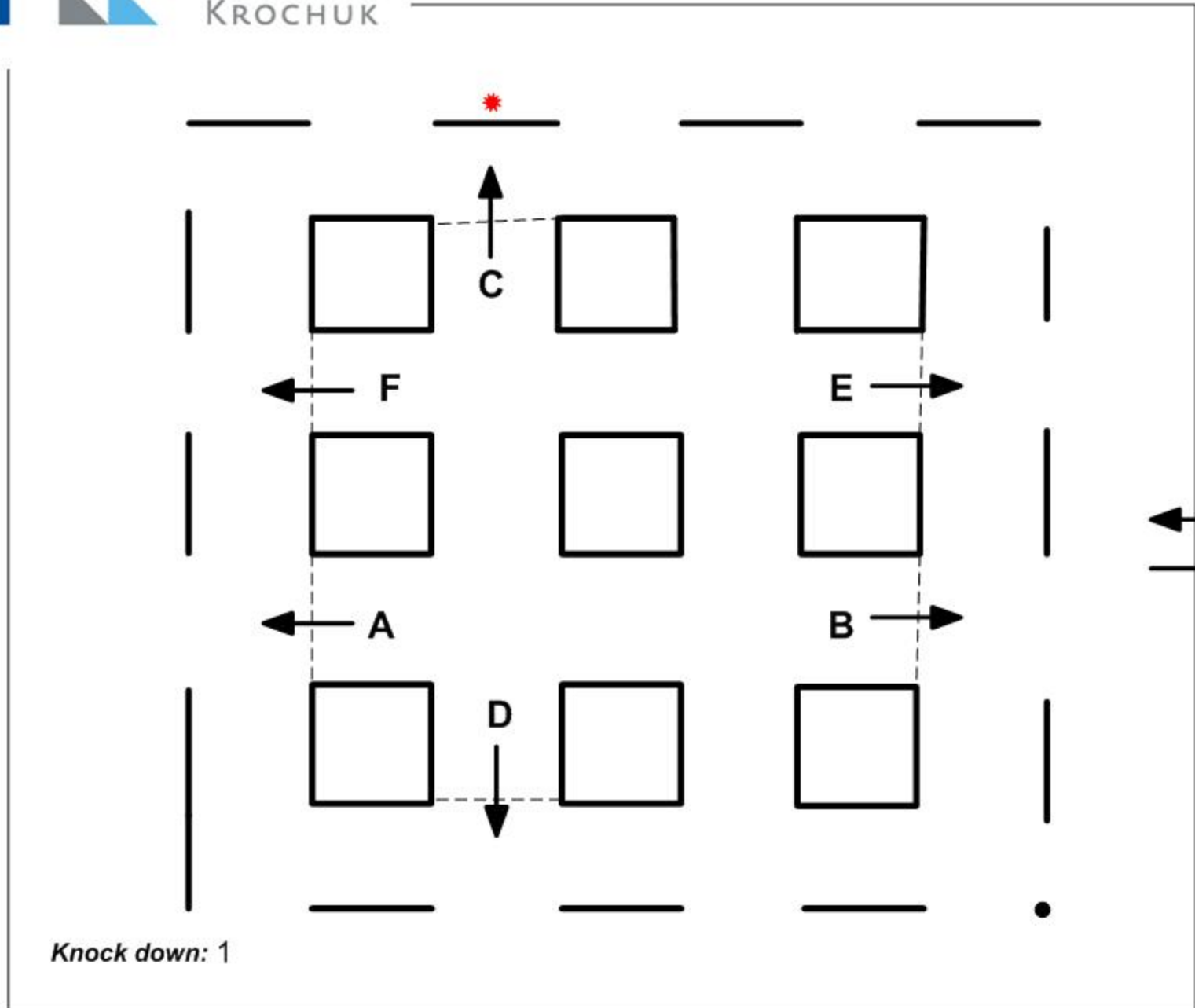

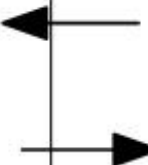
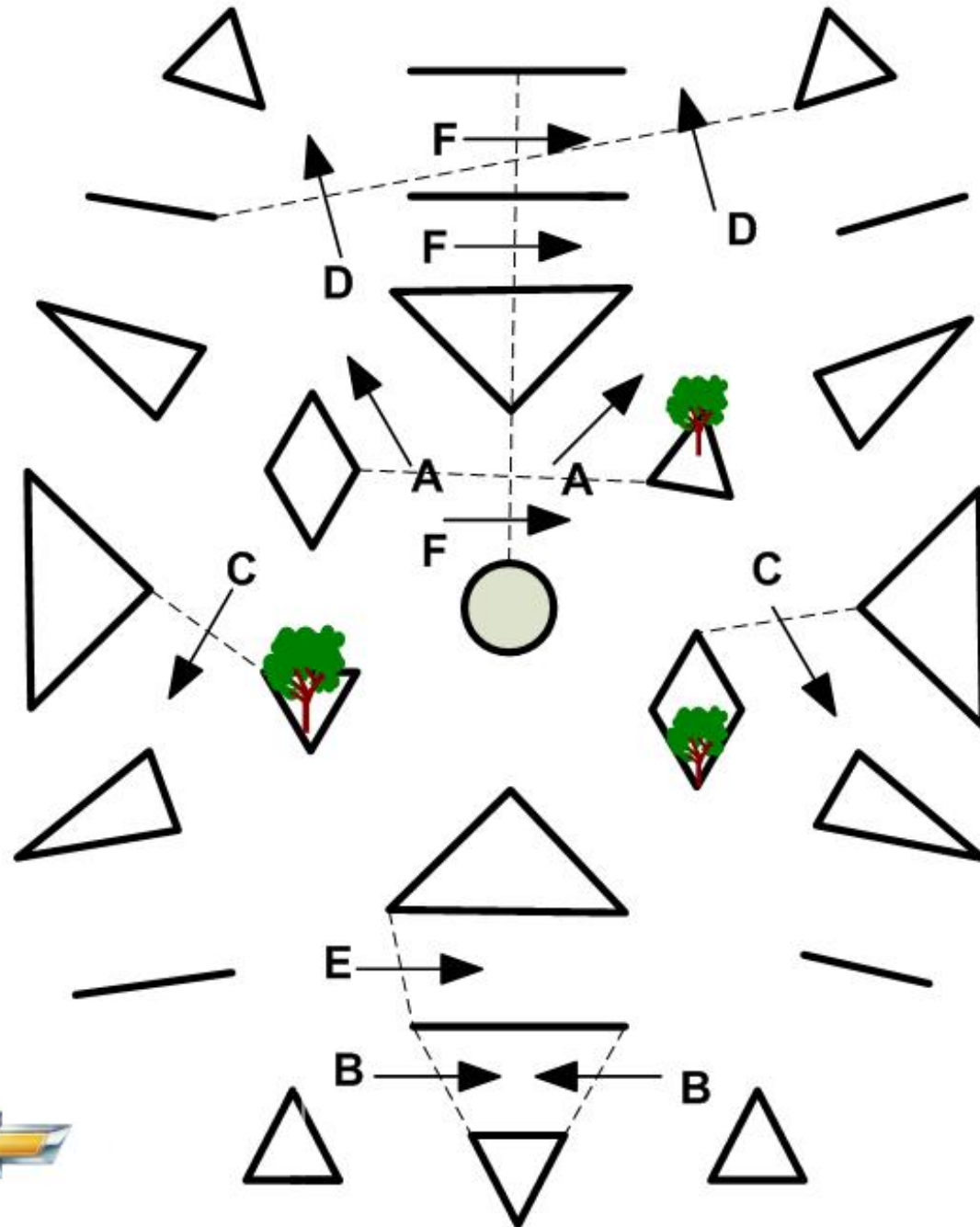

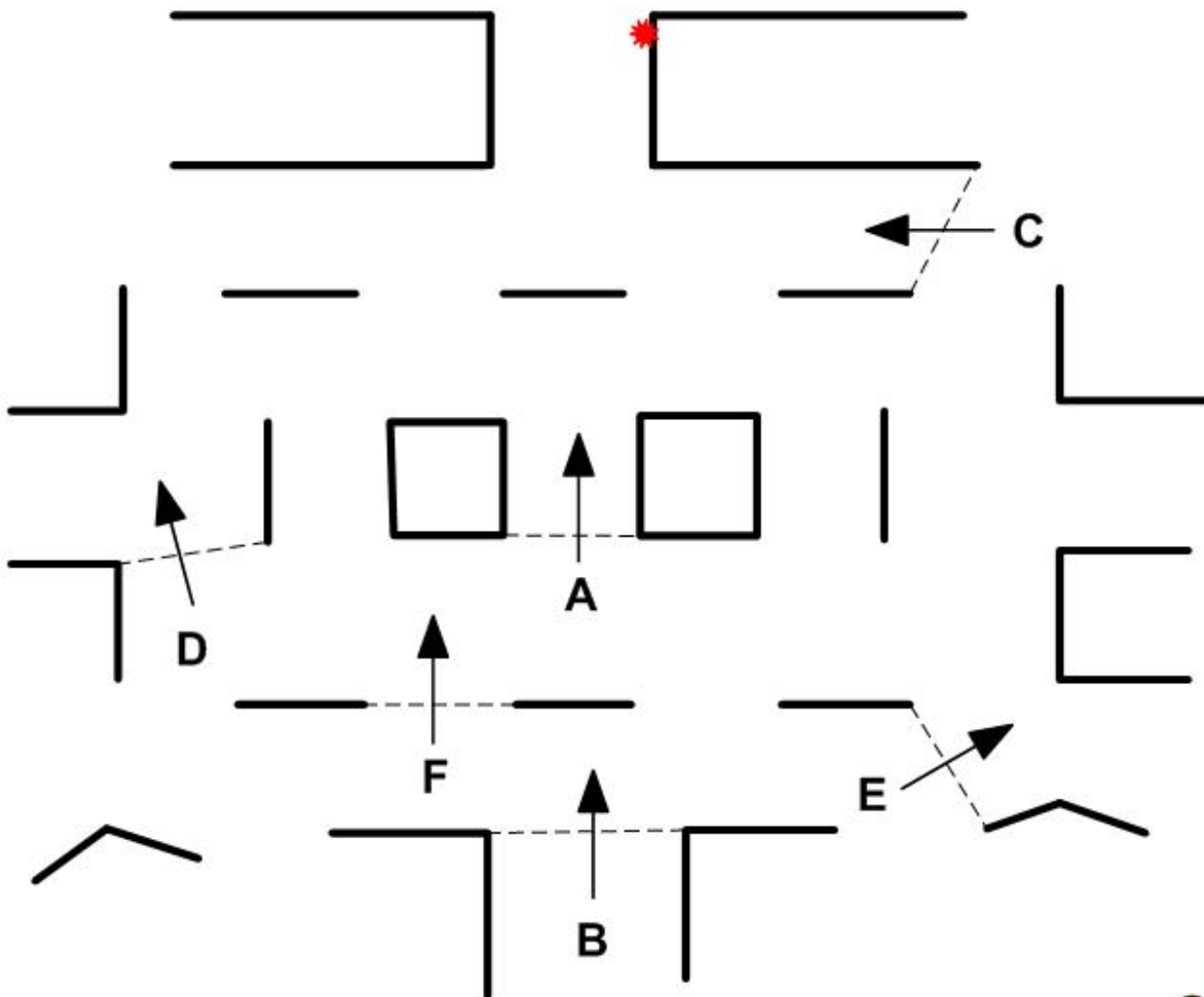
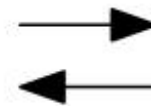

Knock down: 1

